

bigla

Grösse und Form für
jede Situation – mit
einfacher Integration
von Multimedia



factsheet
XF conference

Bigla XF conference

Der Tisch für repräsentative Konferenzlösungen.

X ist die Variable, die sich den persönlichen und multimedialen Bedürfnissen des Benutzers anpasst. F steht für Flow – den Zustand produktiver Harmonie, in dem sich Motivation und Aufmerksamkeit vereinen. Die XF conference Modelle haben es in sich: Da die Tischmitte immer frei bleibt,

kann bei Bedarf zusätzlich eine Steckdosenleiste, eine Öffnungsklappe und ein Kabelkanal in die Tischplatte eingebaut werden. Die Systemplattform XF beruht lediglich auf einem Bein und einem Profil. Dadurch lässt sie sich äusserst flexibel sämtlichen aktuellen und künftigen Bedürfnissen anpassen.

Produktdesign: Daniel Korb



Bigla XF conference

Produkt-Highlights

- Verschiedene Formen und Grössen möglich
- Ausrüstbar mit Multimediaanschlüssen
- Einfaches Kabelmanagement
- Zerlegbares Untergestell (Logistikvorteil)
- Leichtes Aluminium-Gestell
- Swiss CDF Platte



Einrichtungsbeispiel mit allen Tischmodellen

- A Konferenztisch rechteckig
- B Konferenztisch bootsförmig
- C Konferenztisch dreieckig
- D Konferenztisch quadratisch
- E Konferenztisch trapezförmig

Bigla XF conference

Produktübersicht

Gestell-Typen

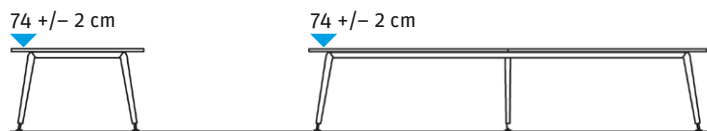

Masse

Konferenztisch rechteckig

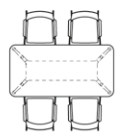

180 x 90

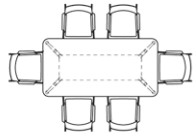

200 x 100

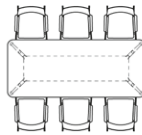

240 x 100

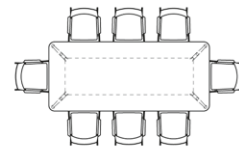

280 x 120

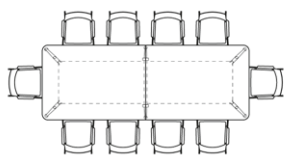

360 x 130

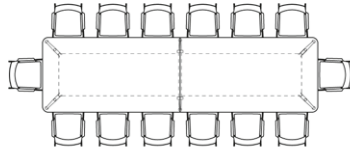

480 x 130

Konferenztisch bootsförmig

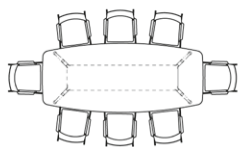

280 x 120 – 90

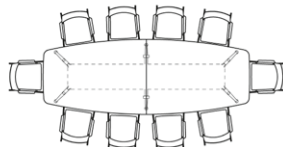

360 x 130 – 90

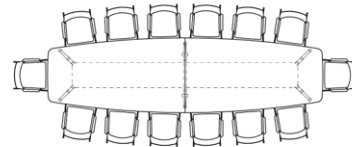

480 x 130 – 90

Konferenztisch dreieckig, rund



140

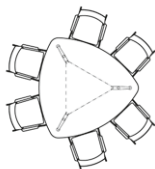

160

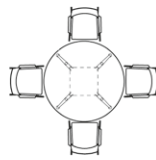

170 x 170

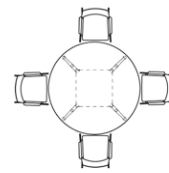

180 x 180

Konferenztisch trapezförmig, quadratisch

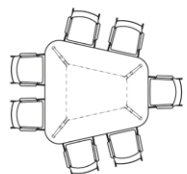

100 x 100

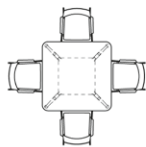

120 x 120

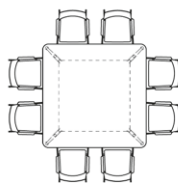

180 x 180

Bigla XF conference

Produktzubehör



Netbox Turn Comfort

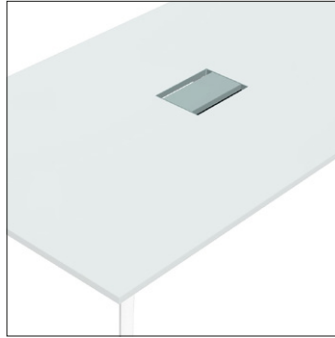

Öffnungsklappe aus Holz

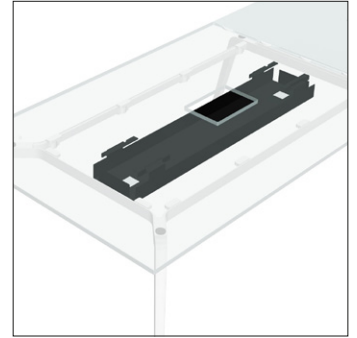

Kabelkanal

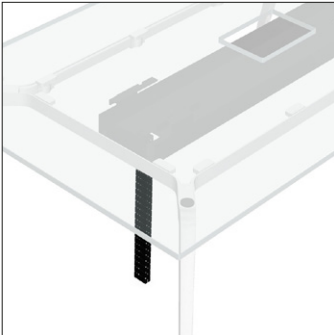

Vertikalkabelführung

Bigla XF conference

Material und Farben

Metall Grundfarben

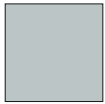

Silber



Anthrazit métallisé



Weiss

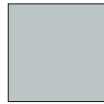

Grau



Anthrazit



Schwarz

Platten Kunstharz beschichtet

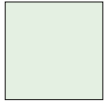

Weiss

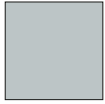

Grau



Buche



Ahorn



Birnbaum

Platten Swiss CDF

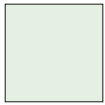

Weiss

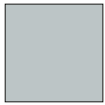

Grau

Platten Holzfurnier Swiss CDF



Buche



Eiche



Nussbaum



Fineline

Platten Linoleum Swiss CDF



Mushroom



Pebble



Charcoal



Nero